

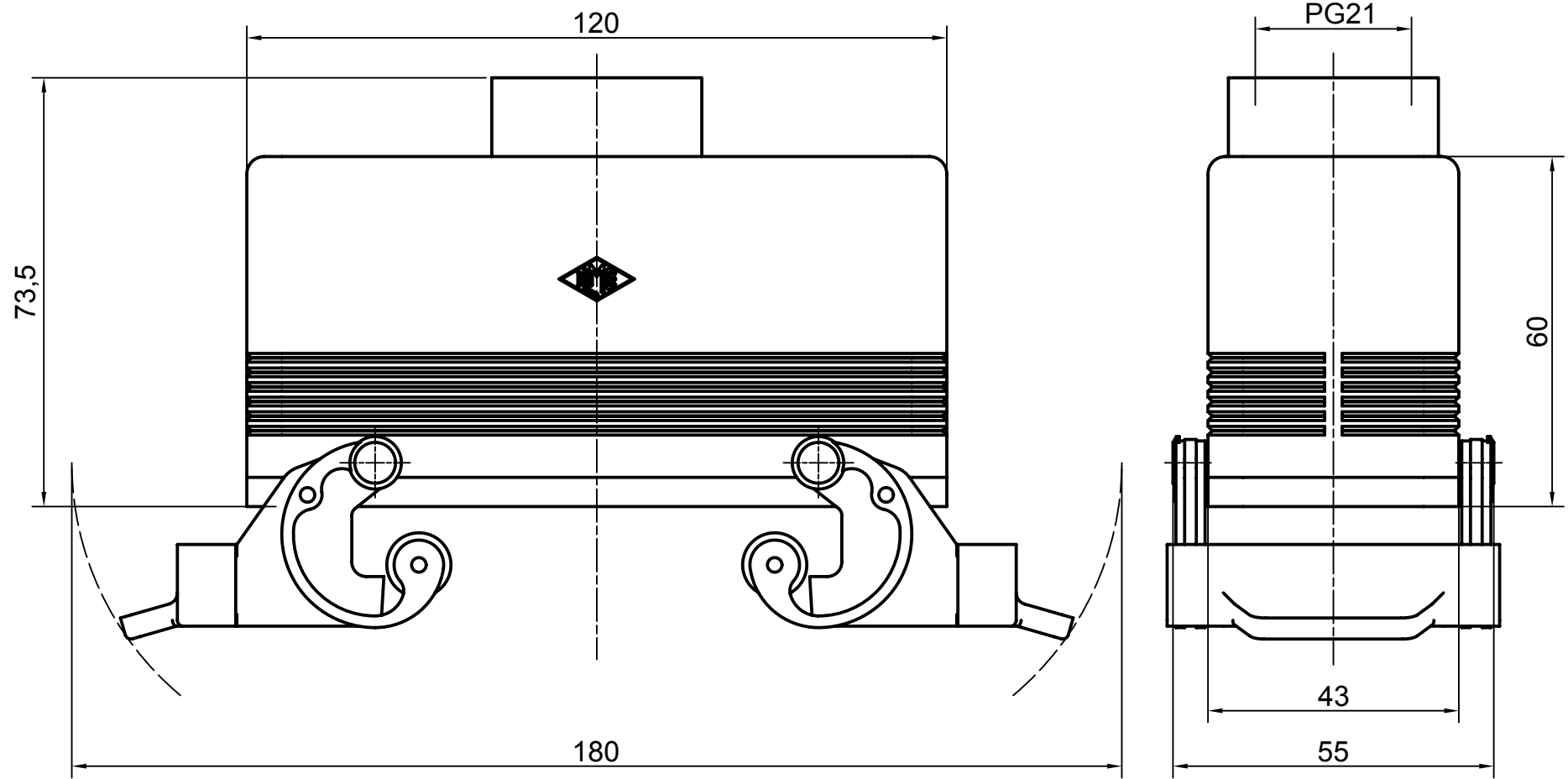

Diritti riservati

All rights reserved



Date 10.01.2007	CMV 16 G	Scale	
Sign.	hood top entry with 2 lev. PG21 ins.	1:1	